

CYTY322B (InSb) HALL-EFFECT ELEMENT

Hall-effect element CYTY322B is made of compound semiconductor material indium stibnite (InSb), which utilizes the Hall-effect principle. It can convert a magnetic flux density signal linearly into voltage output.

FEATURES

- High Magnetic Sensitivity
- Low Offset Voltage
- Miniature Package

TYPICAL APPLICATION

- Magnetic Field Measurement
- Current Sensor
- Detection of Speed
- DC Brushless Motor
- Position Control

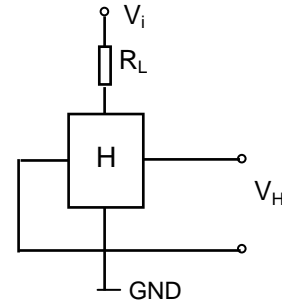

1. Maximum Ratings

(Ta=25°C)

Parameter	Symbol	Rating	Unit
Maximum Input Current	I _{max}	20 (at 25°C)	mA
Maximum Power Dissipation	P _{max}	150 (at 25°C)	mW
Operating Temperature Range	T _{op}	- 40 ~ + 110	°C
Storage Temperature Range	T _{st}	- 40 ~ + 125	°C

2. Electrical Characteristics (Measured at 25°C)

Parameter	Symbol	Measurement Conditions	Min	Max	Unit
Output Hall Voltage	V _H	V _{in} = 1V, B = 50mT	228	370	mV
Input Resistance	R _{in}	I = 0.1mA	240	550	Ω
Output Resistance	R _{out}	I = 0.1mA	240	550	Ω
Offset Voltage	V _O	V _{in} = 1V, B = 0G	- 7	+ 7	mV
Temp. Coeff. of V _H	α	T _a = 0 ~ + 40°C AVG. B=50mT, I _c =5mA	-	- 1.8	% /°C
Temp. Coeff. of R _{in} , R _{out}	β	T _a = 0 ~ + 40°C AVG. B=0, I _c =0.1mA	-	- 1.8	% /°C
Dielectric strength		100V DC	1.0		MΩ

V_H = V_{HM} - V_O (V_{HM} : The output voltage measured at 50mT)

3. Rank Classification and Mark on Output Hall Voltage

Output Hall Voltage, V _H (mV)	Rank	Measurement Conditions
228 ~ 274	E	V _{in} = 1V, B = 50mT (Constant Voltage Drive)
266 ~ 320	F*	
310 ~ 370	G*	

*Sensors with rank F and G are custom made sensors

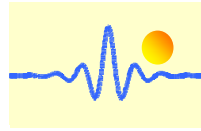

4. CHARACTERISTIC CURVES (only for references)

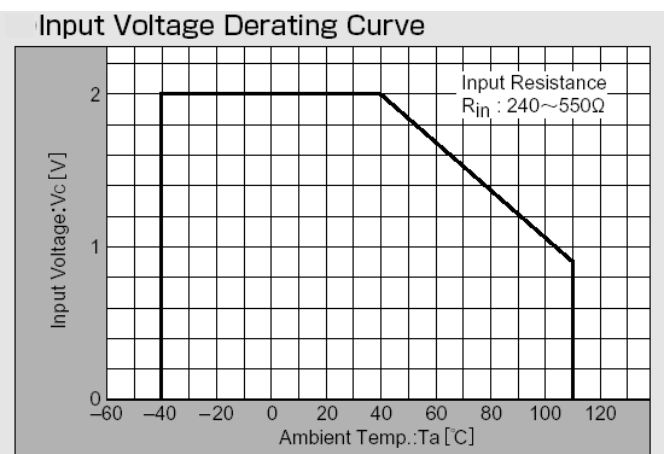
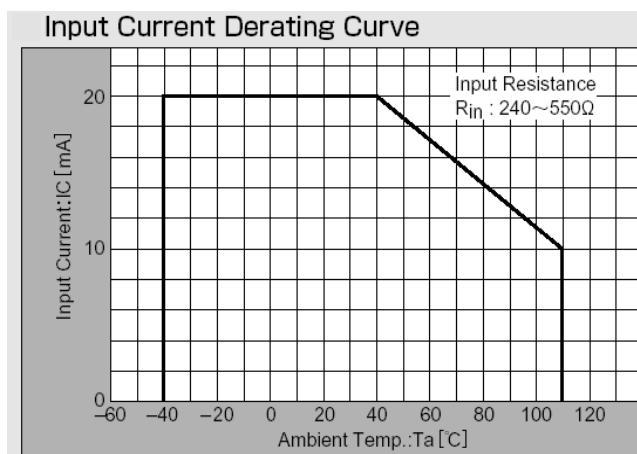
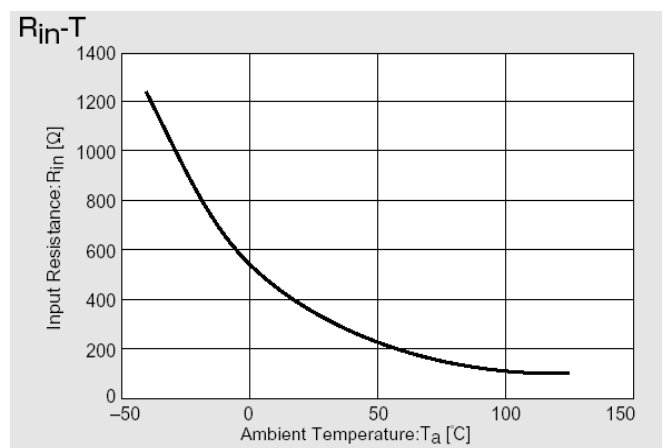
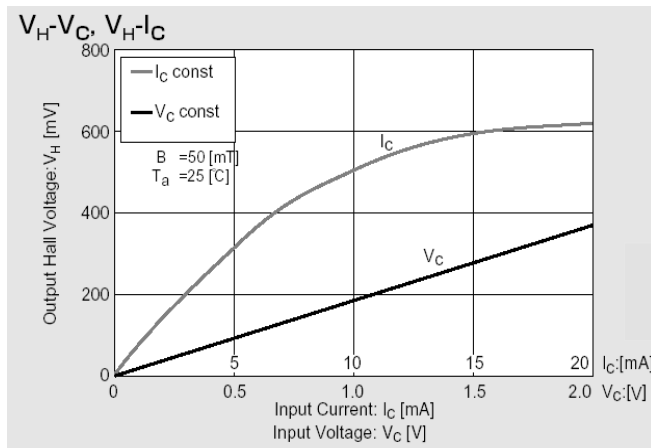
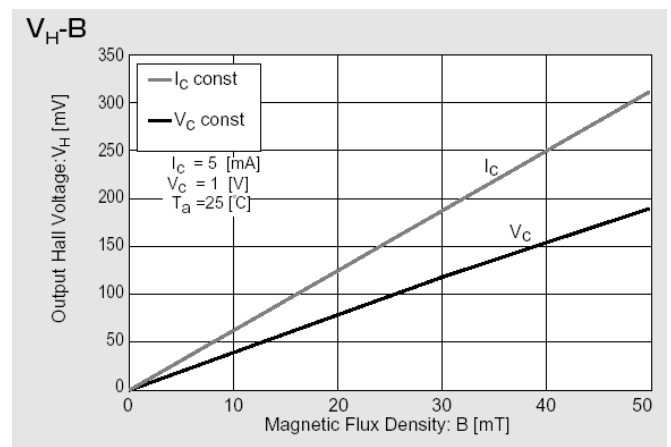
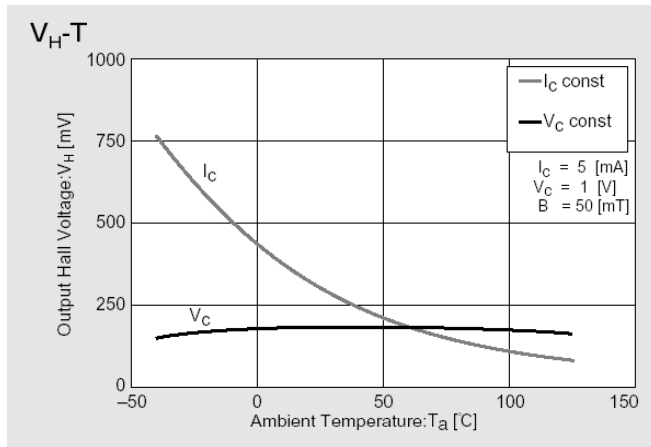

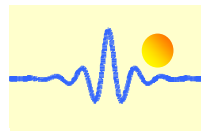

5. Connection

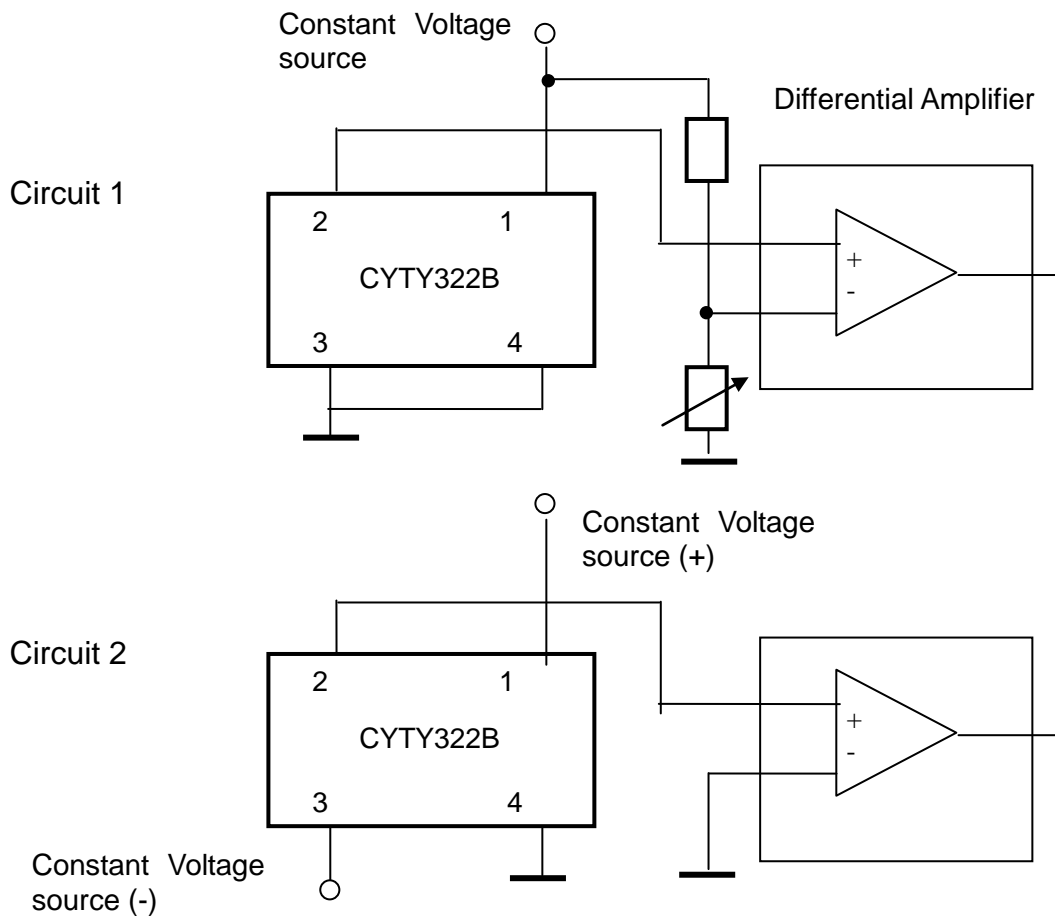

6. Application Notes

The Hall voltage V_H can be positive and negative. But if one connects the sensor as follows (circuit 1):

Pin 1: positive input voltage V_+ , for instance +5VDC.
Pin 3: GND
Pin 2: OUTPUT
Pin 4: GND

One can only measure the positive voltage at the pin 2. This means that the output voltage at zero magnetic field is not zero. This voltage is called as offset voltage. The output voltage in this case is not equal to the Hall voltage. The output voltage is equal to the sum of offset voltage and Hall voltage.

The offset voltage will be zero if you connect double power supplies V_+ and V_- to the sensor (circuit 2):

Pin 1: positive input voltage V_+ , for instance +5VDC.
Pin 3: negative input voltage V_- , for instance -5VDC
Pin 2: OUTPUT
Pin 4: GND

In this case the output voltage is equal to the Hall Voltage.

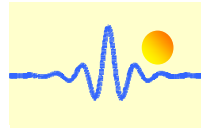

7. External Dimensions (Unit: mm)

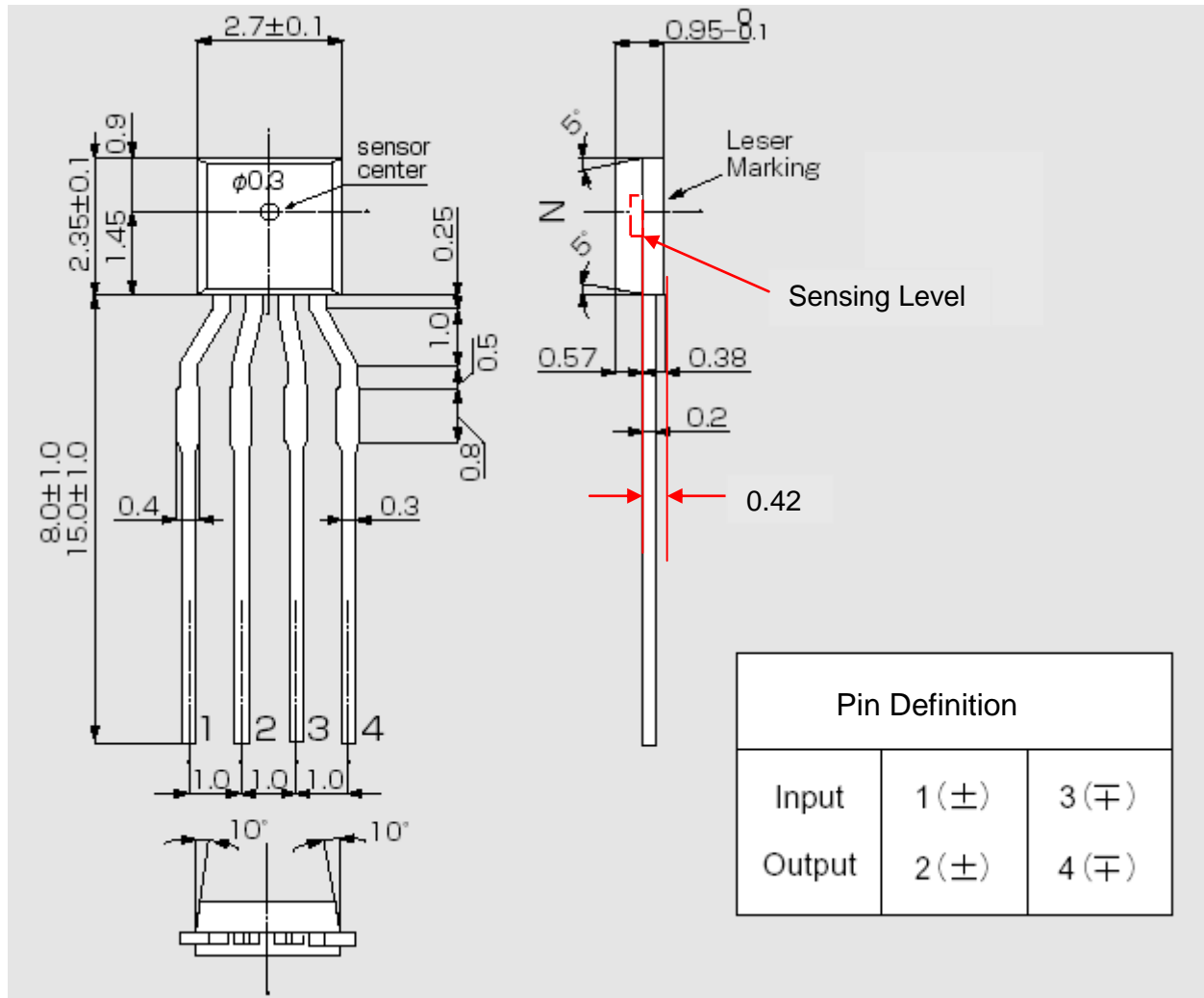

8. Method for Mounting

8-1. Soldering Conditions on PCB

1. No Rapid Heating and Cooling.
2. Recommended Preheating condition is at 130~150°C for 2~3minutes.
3. Recommended Reflowing condition is at 220~230°C for 10~15seconds.

8-2. Soldering Method and Temperature

Items	Methods	Temperature
Reflow	Soldering by Passing the Heated Zone	Max 250°C in 20sec
Solder Iron	Soldering by Soldering Iron	Max 300°C in 3sec

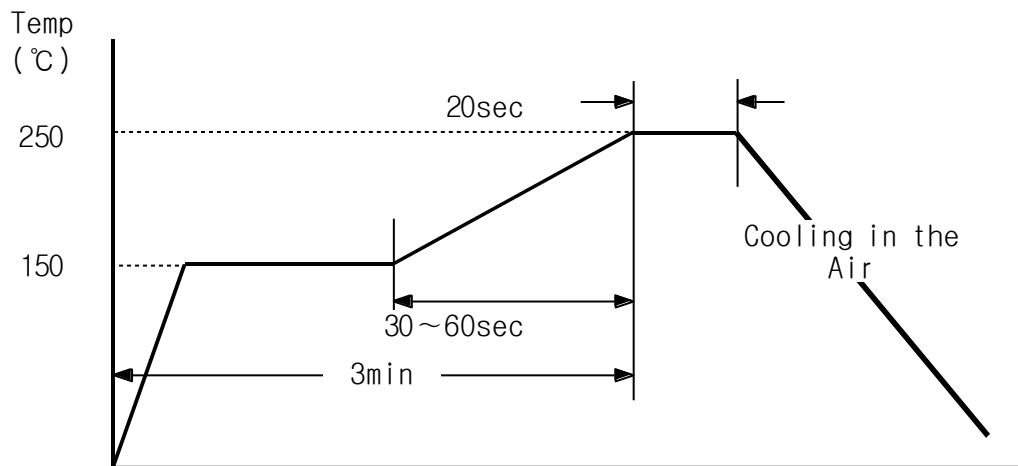
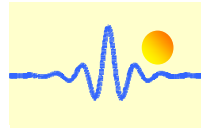

9. RELIABILITY

9.1 TEST CONDITION

	CONDITION
HIGH TEMP. STORAGE	Ta=110°C,t=1000HR
LOW TEMP. STORAGE	Ta=-40°C,t=1000HR
HIGH TEMP. OPERATION	Ta=100°C,Iopr=6mA,t=1000HR
LOW TEMP. OPERATION	Ta=-20°C,Iopr=6mA,t=1000HR
HIGH TEMP. HIGH HUMIDITY OPERATION	Ta=60°C, HR=90%,Iopr=9mA,t=1000HR
HUMIDITY	Ta=60°C,HR=90%, t=1000HR
PCT	Ta=121°C,HR=100%, Pv=2atm, t=24HR
THERMAL SHOCK	T(L)=-55°C,T(H)=150°C, t=(L,H)=30min,M=30CYCLE
SOLDERING HEAT RESISTANCE	solder temp=250±5°C, t=10sec,REFLOW
SOLDABILITY	solder temp=230±5°C, t=5sec,dip
TERMINAL STRENGTH	TENSION 300g/30sec
SURGE	V=500V, C=200pF, R=0Ω (test method EIAJ EDX 8503)

9.2 CRITERION FOR JUDGING

After each reliability test, samples should be kept for at least 24 hrs at room temp. & humidity, and then measured. The change rates should be confined within the ranges as follows.

item	OK SPEC	NG/OK
ΔRin	UNDER ±20%	OK (SPEC SATISFYING)
ΔRout	UNDER ±20%	
ΔVH	UNDER ±20%	
ΔVo/VH	UNDER ± 5%	