

High Sensitivity Speed Sensor IC CYGTS9633 with Dual Quadrature Outputs

CYGTS9633 is a differential Hall Effect sensor IC with two independent channels providing quadrature outputs. The device provides a high sensitivity and a superior stability over temperature and symmetrical thresholds in order to achieve a stable duty cycle. The integrated circuit, which is based on Hall Effect principle, is response to changing differential magnetic fields created by ferrous targets when coupled with a magnet. By use of the A and B quadrature outputs, the device is particularly suitable for speed and direction of magnetic ring or ferromagnetic toothed wheels. The device is packaged in a 4-pin plastic SIP. It is lead (Pb) free, with 100% matte tin plated lead frame.

Features

- Two independent digital quadrature A/B outputs
- Accurate true zero-crossing switch-point
- South and North pole pre-induction possible
- Large air gap
- 3.8V to 24V supply operating range
- Low power consumption 6.5mA (typ.)
- Wide operating temperature range -40°C ~150°C
- Protection against over-voltage in all PIN
- Reverse-current protection in power supply V_{DD} PIN
- Output protection against electrical disturbances

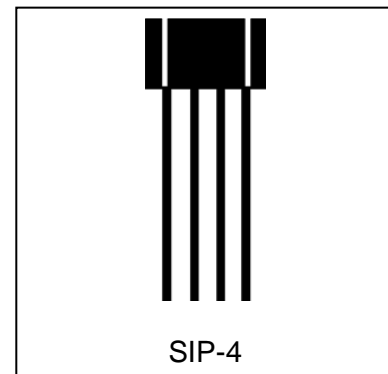

Applications

Automotive and Heavy Duty Vehicles	Industrial Areas:
<ul style="list-style-type: none"> • Camshaft and crankshaft speed and position • Transmission speed • Tachometers • Anti-skid/traction control 	<ul style="list-style-type: none"> • Sprocket speed • Chain link conveyor speed/distance • Stop motion detector • High speed low cost proximity • Tachometers, counters.

Device Information

Part number	Packing	Mounting	Temperature range	Marking
CYGTS9633VB	Bulk, 500pcs/bag	4-pin SIP	-40°C~150°C	9633

Operating Range

Parameter	Symbol	Test Conditions	Min	Typ	Max	Units
Back Bias Range	B _{Bias}	Operating	-500	--	500	mT
Supply Voltage	V _{DD}	Operating	3.8	12	24	V
Operating Temperature	T _A		-40	~	150	°C
Storage Temperature	T _S		-65	~	175	°C

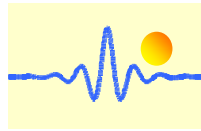

Electrical and Magnetic Specifications

Operating Parameters $T_A = -40^{\circ}\text{C}$ to 150°C , $V_{DD} = 5\text{V}$ (unless otherwise specified)

Parameter	Symbol	Test Conditions	Min	Typ.	Max	Unit
Supply Voltage	V_{DD}	Operating	3.8	12	24	V
Supply Current	I_{DD}	$V_{DD}=3.8$ to 24V	4.5	6.5	8.5	mA
Output Saturation Voltage	V_{sat}	$I_{out}=30\text{mA}$, $T_A=25^{\circ}\text{C}$	--	210	400	mV
Output Leakage Current	I_{Leak}	$V_{out}=24\text{V}$	--	--	10	μA
Overvoltage protection at supply voltage	V_{SP}	$I_{DD} = 10\text{mA}$	30	35	40	V
Overvoltage protection at output terminal	V_{OP}	$I_{out}=1\text{mA}$, $V_{out}=\text{High}$	30	35	40	V
Over current protection	OCP ¹	$T_A=25^{\circ}\text{C}$	40	--	--	mA
Power on time	t_{po} ²	$V_{DD} > 3.8\text{V}$	--	3.8	9.0	ms
Settling time	t_{settle} ³	$V_{DD}>3.8\text{V}$, $f=1\text{kHz}$	0	--	50	ms
Response time	$t_{response}$ ⁴	$V_{DD}>3.8\text{V}$, $f=1\text{kHz}$	3.8	--	59	ms
Output Rise Time	T_R ⁵	$R1=1\text{k}\Omega$ $C=20\text{pF}$	--	0.4	1.0	μs
Output Fall Time	T_F	$R1=1\text{k}\Omega$ $C=20\text{pF}$	--	0.35	1.0	μs
Upper corner frequency	f _{cu}	-3dB, single pole	20	--		kHz
Lower corner frequency	f _{cl}	-3dB, single pole	--	--	5	Hz
Back Bias Range	B_{Bias}	Operating	-500	--	500	mT
Operating point of channel 1	ΔB_{OP1}	$f=1\text{kHz}$, $B_{diff}=5\text{mT}$	--	--	0	mT
Release point of channel 1	ΔB_{RP1}	$f=1\text{kHz}$, $B_{diff}=5\text{mT}$	0	--	--	mT
Hysteresis of Channel 1	B_{HYS1}	$f=1\text{kHz}$, $\Delta B=5\text{mT}$	0.5	1.5	2.5	mT
Switching point center of channel 1	ΔB_{M1}	$(B_{OP} + B_{RP})/2$	-2.0	0	2.0	mT
Operating point of channel 2	ΔB_{OP2}	$f=1\text{kHz}$, $B_{diff}=5\text{mT}$	--	--	0	mT
Release point of channel 2	ΔB_{RP2}	$f=1\text{kHz}$, $B_{diff}=5\text{mT}$	0	--	--	mT
Hysteresis of Channel 2	B_{HYS2}	$f=1\text{kHz}$, $\Delta B=5\text{mT}$	0.5	1.5	2.5	mT
Switching point center of channel 2	ΔB_{M2}	$(B_{OP} + B_{RP})/2$	-2.0	0	2.0	mT

¹ I_{OUT} does not change state when $I_{OUT}=OCP$.

² Time required initializing device.

³ Time required for the output switch points to be within specification.

⁴ Equal to $t_{po} + t_{settle}$.

⁵ Output Rise Time will be dominated by the RC time constant.

Absolute Maximum Ratings

Parameter	Symbol	Minimal value	Maximal value	Unit
Power supply voltage	V_{DD}	-30	30	V
Power output current	I_{DD}	-10	25	mA
Output terminal voltage	V_{OUT}	-0.5	30	V
Output terminal current sink	I_{SINK}	0	40	mA
Operating ambient temperature	T_A	-40	150	$^{\circ}\text{C}$
Maximum junction temperature	T_J	-40	165	$^{\circ}\text{C}$
Storage temperature	T_{STG}	-65	175	$^{\circ}\text{C}$

Note: Stresses above those listed here may cause permanent damage to the device. Exposure to absolute maximum rating conditions for extended periods may affect device reliability.

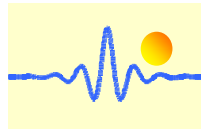

ESD (Emergency Shutdown System) Protection

Human Body Model (HBM) Tests

Parameter	Symbol	Max.	Unit	Note
ESD	V_{ESD}	± 4.0	kV	According to Standard AEC-Q100-002

Pin Configuration

4-Terminal SIP VB package (Top View)

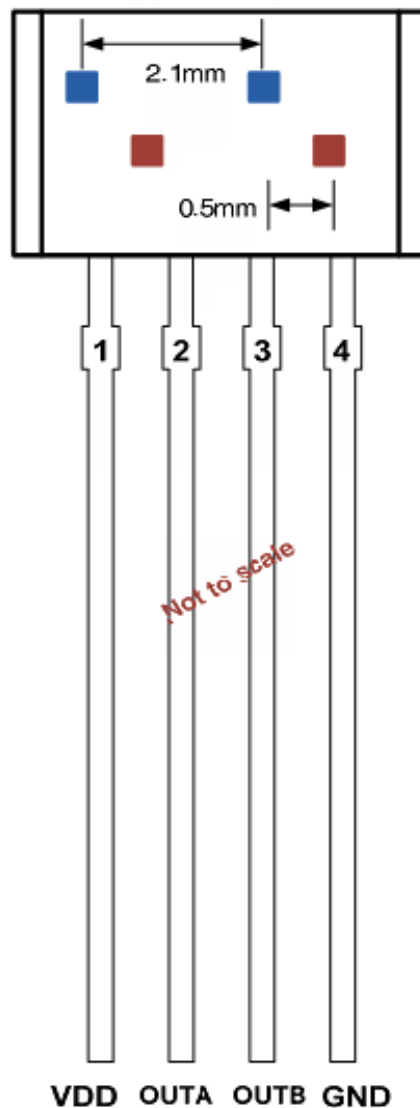

Pin No.	Symbol	Type	Description
1	V_{DD}	Supply voltage	3.8V to 24V power supply
2	OUTA	Output	Open-drain output required a pull-up resistor
3	OUTB	Output	Open-drain output required a pull-up resistor
4	GND	Ground	Ground terminal

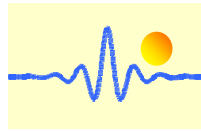

Functional Block Diagram

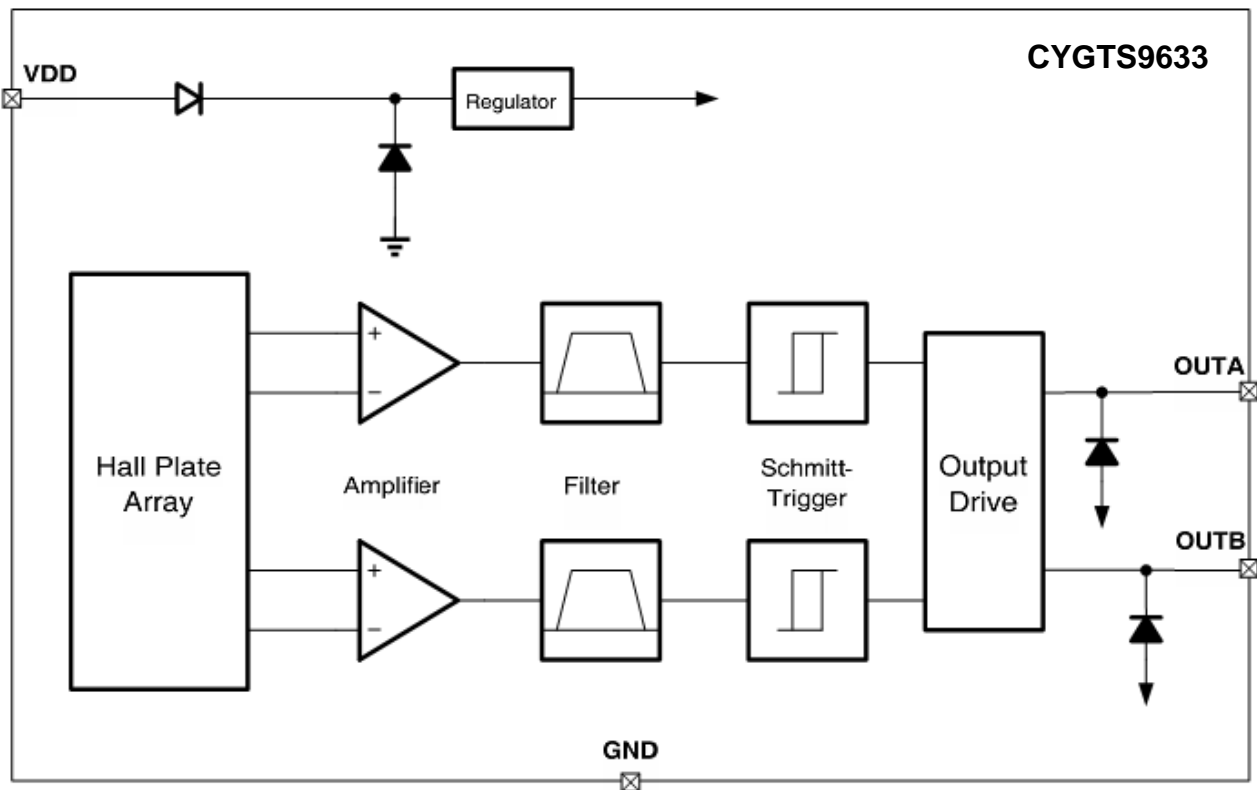

Functional Description

The CYGTS9633 integrates two independent differential Hall-effect sensor ICs. The Hall IC supports four Hall elements, with magnet back-biased, which sense the magnetic profile of the ferrous gear target simultaneously, but at different points, generating two differential internal analog voltages, that is processed for precise switching of the digital output signals.

For each of two independent channels, the sensor detects the motion and position of ferromagnetic structures by measuring the differential flux density of the magnetic field. Changes in field strength at the sensor face, which are induced by a moving target, are sensed by the two integrated Hall elements. The Hall elements generate signals that are differentially amplified by on-chip electronics. This differential design provides immunity to radial vibration within the operating air gap range of the CYGTS9633, by rejection of the common mode signal. Steady-state magnetic and systematic offsets are eliminated using an on-chip differential band-pass filter. This filter also provides relative immunity to interference from electromagnetic sources.

The Hall IC is self-calibrating with a temperature compensated amplifier and offset cancellation circuitry. Its internal voltage regulator provides supply noise rejection throughout the operating voltage range. Changes in temperature do not greatly affect this sensor due to the stable amplifier design and the offset rejection circuitry. The Hall elements and signal processing electronics are integrated on the same silicon substrate, using a proprietary BiCMOS process. The sensor CYGTS9633 is offered in a lead (Pb) free 4-pin SIP package with a 100% matte tin plated Lead frame.

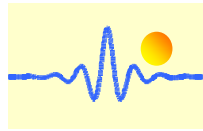

Gear Tooth Sensing

In the case of ferromagnetic toothed wheel application the IC has to be biased by the South or North Pole of a permanent magnet which should cover both Hall probes

The maximum air gap depends on

- the magnetic field strength (magnet used; pre-induction), and
- the toothed wheel that is used (dimensions, material, etc.)

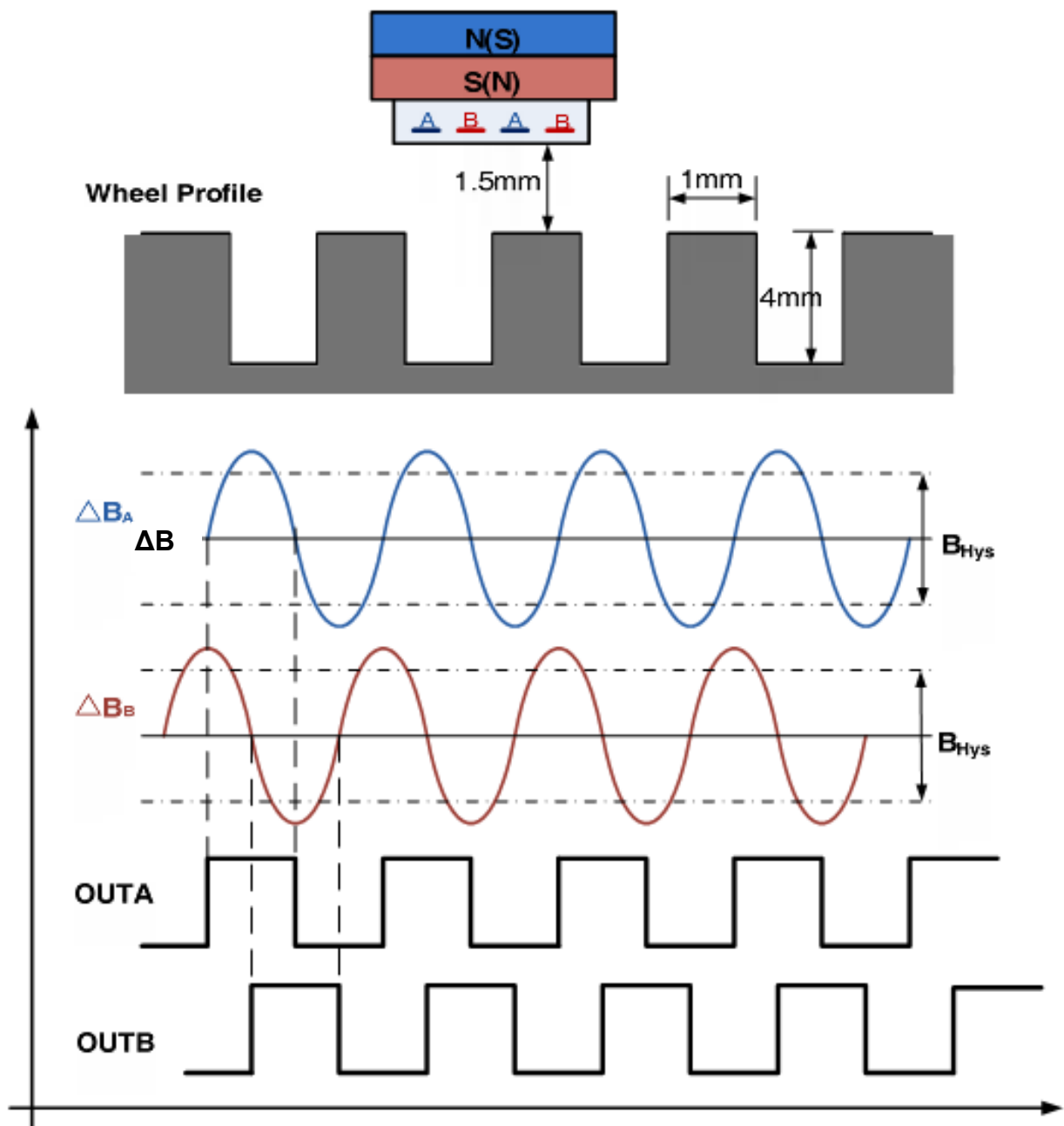

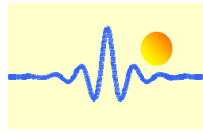

Recommended Application

The CYGTS9633 contains an on-chip voltage regulator and can operate over a wide supply voltage range. In applications that operate the device from an unregulated power supply, transient protection must be added externally. For applications using a regulated line, EMI/RFI protection may still be required.

Three-Wire Connection

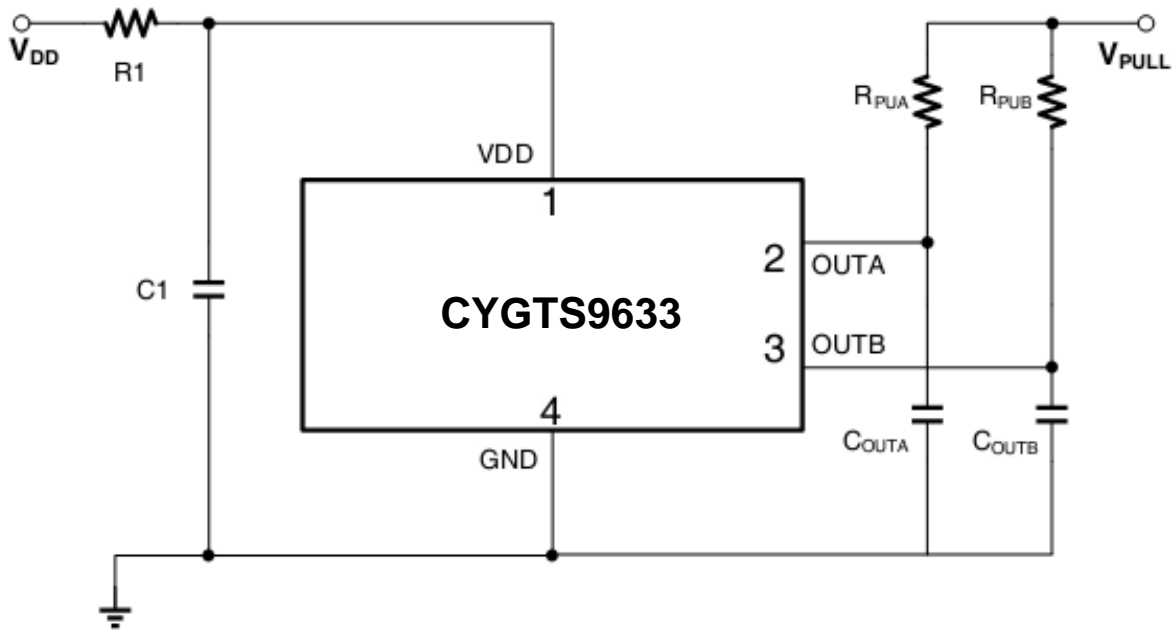

Component	Value	Units
R_{PUA} / R_{PUB}	1.2	$k\Omega$
R1	200	Ω
C1	0.1	μF
C_{OUTA} / C_{OUTB}	1.0	μF

1. Pull-up resistor not required for protection but for normal operation
2. R1 is for improved CI performance
3. C_{OUT} is for improved BCI performance

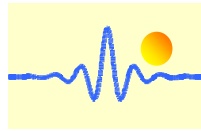

Thermal Characteristics

Symbol	Parameter	Test Conditions	Rating	Units
R _{QJA}	VB Package thermal resistance	Single-layer PCB, with copper limited to solder pads	177	°C/W

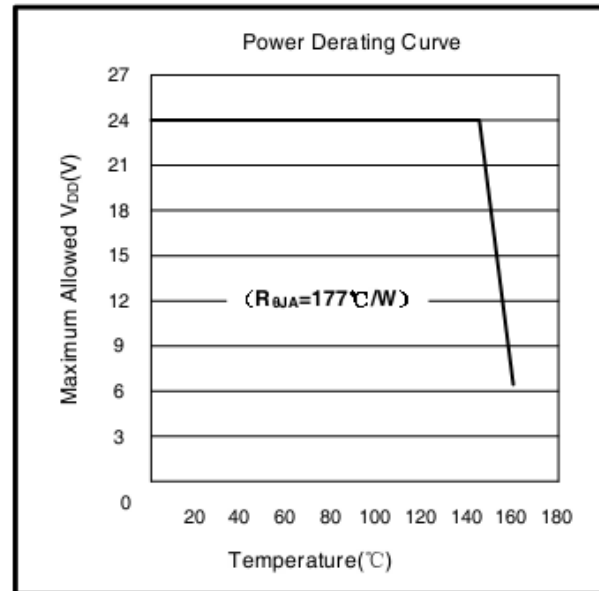
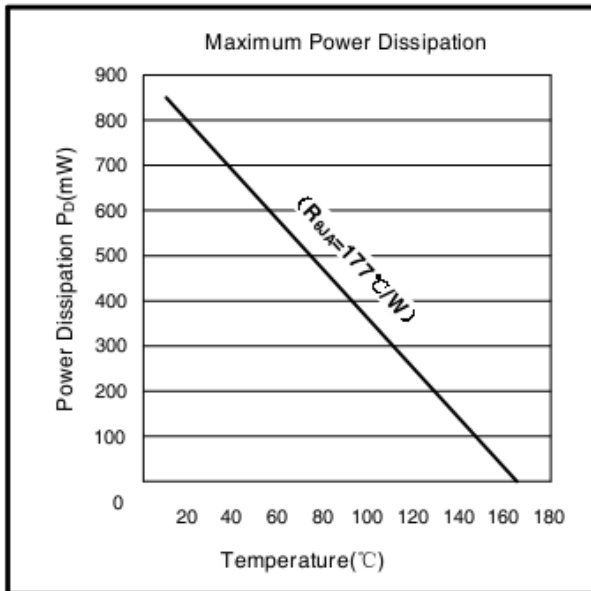

Power Derating Description

The device must be operated below the maximum junction temperature of the device, $T_{J(max)}$. Under certain combinations of peak condition, reliable operation may require derating supplied power or improving the heat dissipation properties of the application. The package Thermal Resistance, $R_{\theta JA}$, is figure of merit summarizing the ability of the application and device to dissipate heat from the junction, through all paths to the ambient air. Its primary component is an Effective Thermal Conductivity, K , of the printed circuit board, including adjacent devices and traces. Radiation from the die through the device case, $R_{\theta JC}$, is relatively small component of $R_{\theta JA}$. Ambient air temperature, T_A , and air motion are significant external factors, damped by over molding.

The effect of varying power levels (Power Dissipation, P_D), can be estimated. The following formulas represent the fundamental relationships used to estimate T_J , at P_D .

$$P_D = V_{DD} \times I_{DD} \quad (1)$$

$$\Delta T = P_D \times R_{\theta JA} \quad (2)$$

$$T_J = T_A + \Delta T \quad (3)$$

For example $T_A = 25^\circ\text{C}$, $V_{DD} = 12\text{V}$, $I_{DD} = 3.5\text{mA}$, $R_{\theta JA} = 177^\circ\text{C/W}$, we get

$$P_D = V_{DD} \times I_{DD} = 12\text{V} \times 3.5\text{mA} = 42\text{mW}$$

$$\Delta T = P_D \times R_{\theta JA} = 42\text{mW} \times 177^\circ\text{C/W} = 7.5^\circ\text{C}$$

$$T_J = T_A + \Delta T = 25^\circ\text{C} + 7.5^\circ\text{C} = 32.5^\circ\text{C}$$

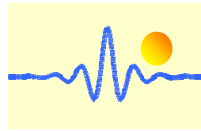

Empirical Result

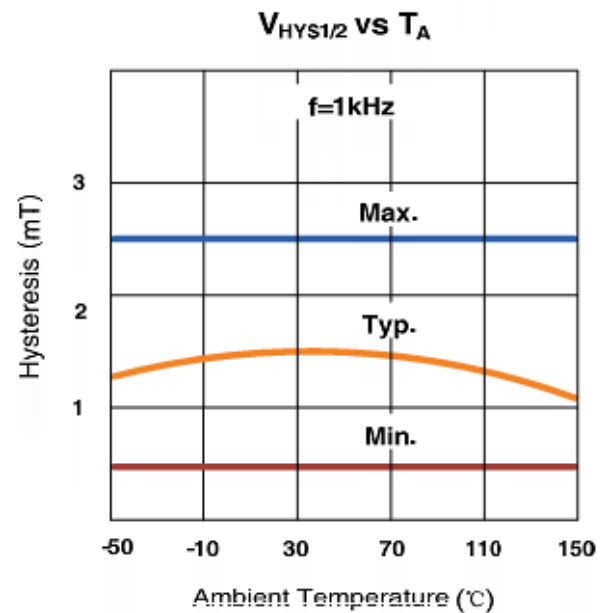
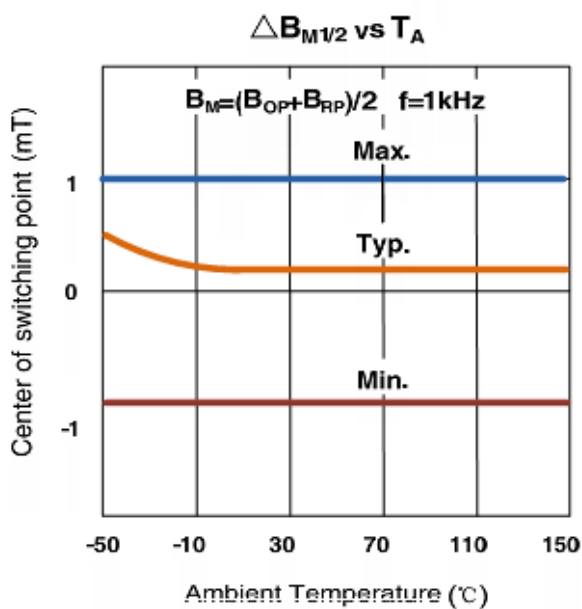
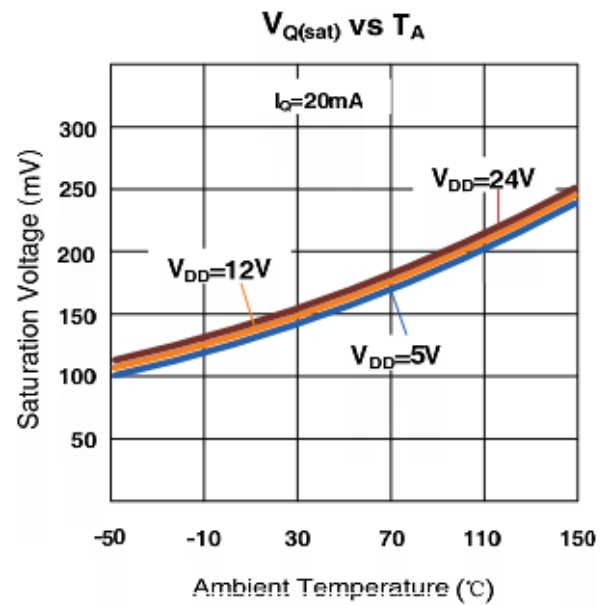
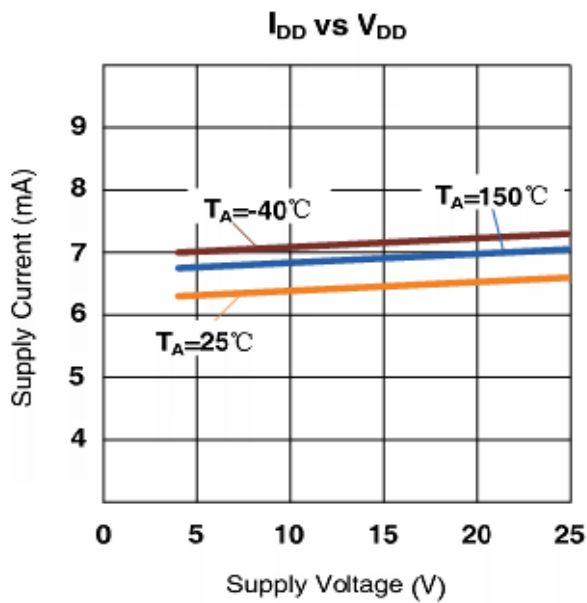

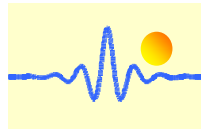

Package Designator

4-Terminal VB Package

Dimension:mm

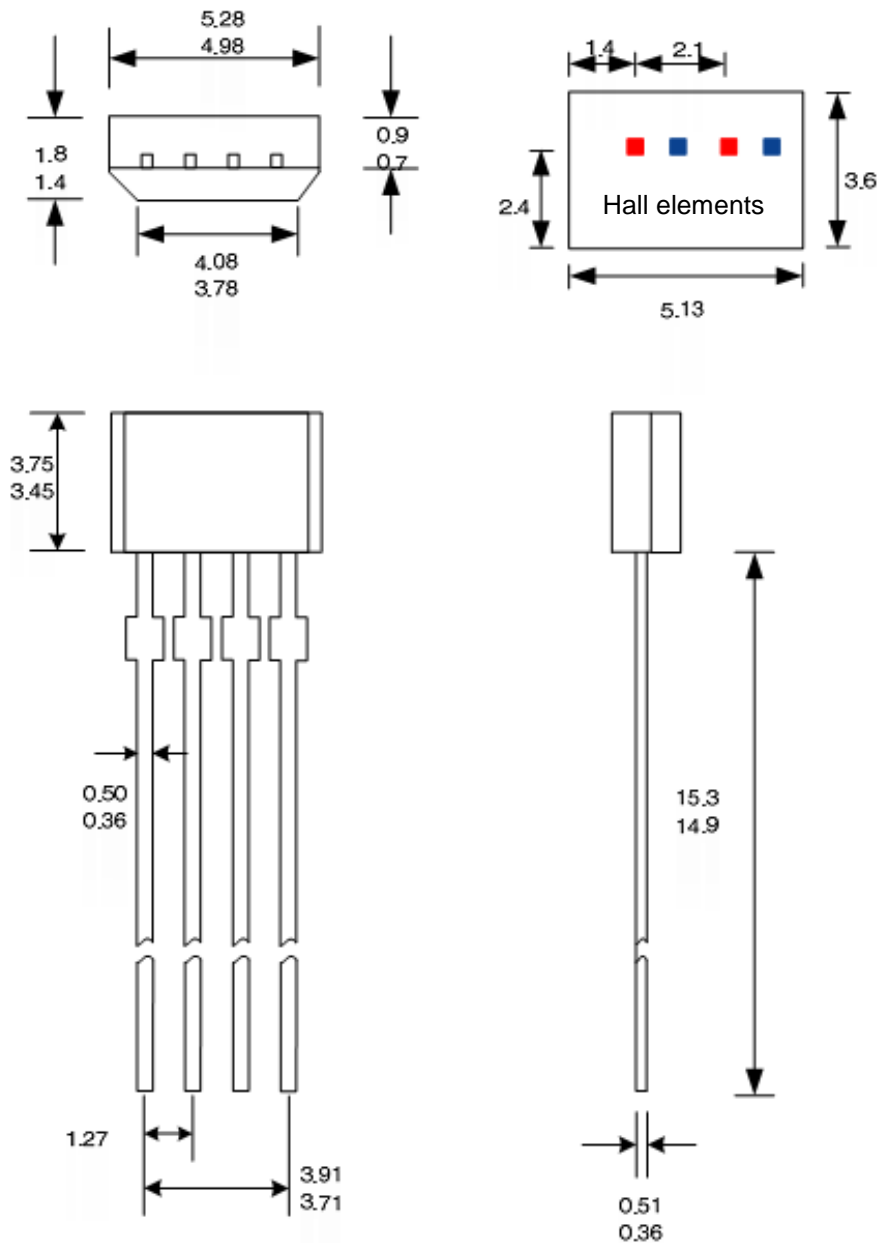

Notes:

1. Exact body and lead configuration at vendor's option within limits shown.
2. Height does not include mold gate flash.
3. Where no tolerance is specified, dimension is nominal.